

# TANEX IND

## HANDRAILS

PH 604-540-9328  
FAX 604-522-1961

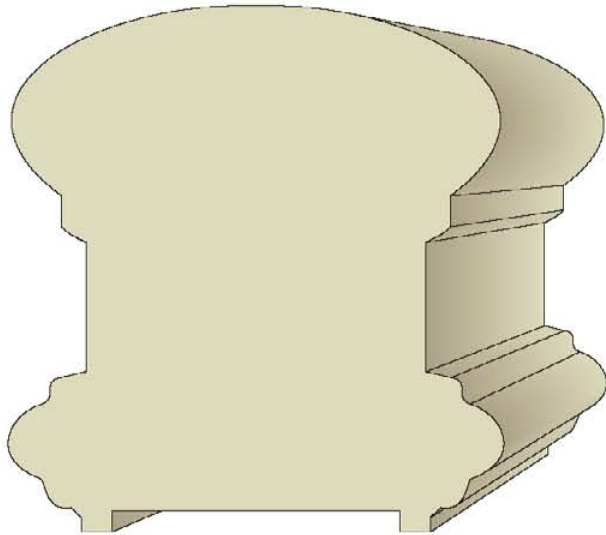

**HM440**  
2 1/2" X 2 3/4"

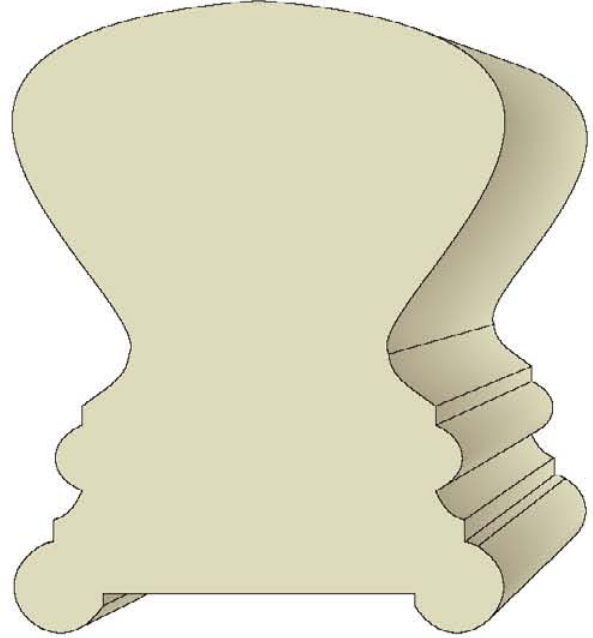

**HM441**  
2 1/2" X 3 5/16"

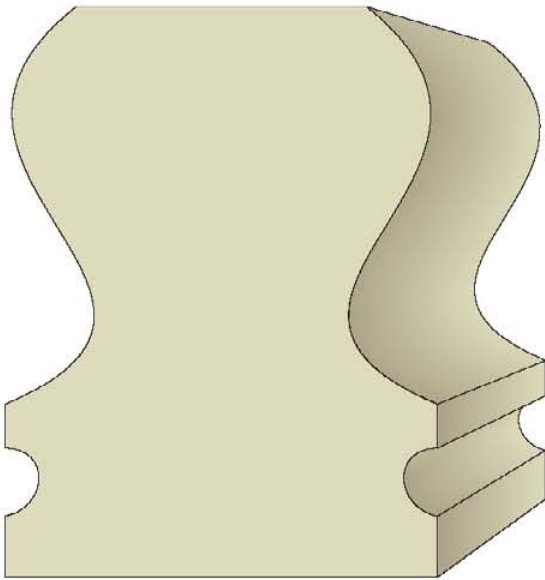

**HM442**  
2 5/16" X 3"

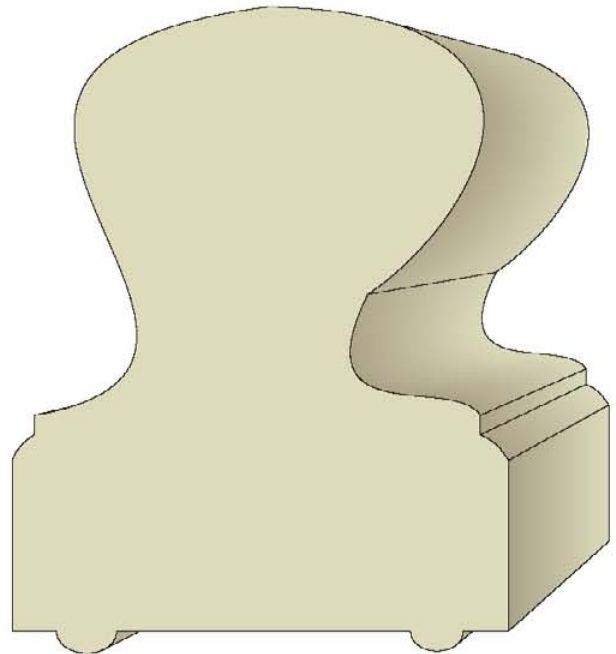

**HM443**  
2 9/16" X 3 3/8"

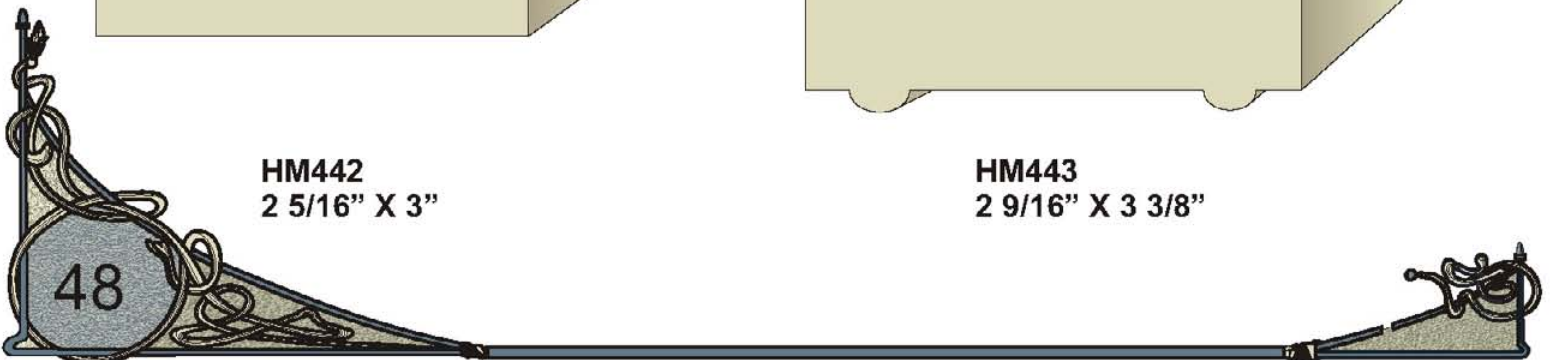

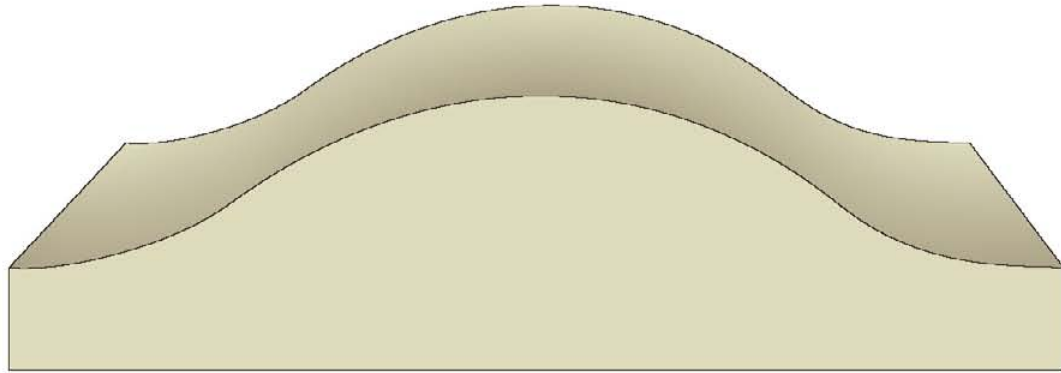
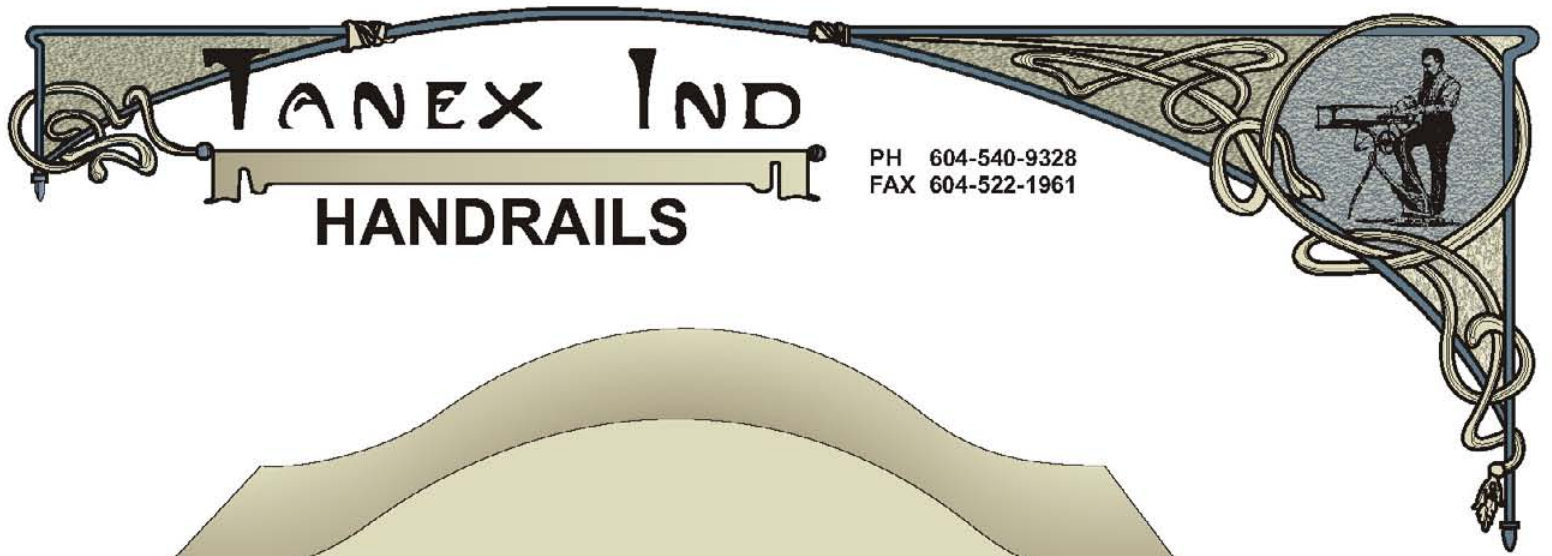

**HM621**  
1 1/2" X 5 1/2"

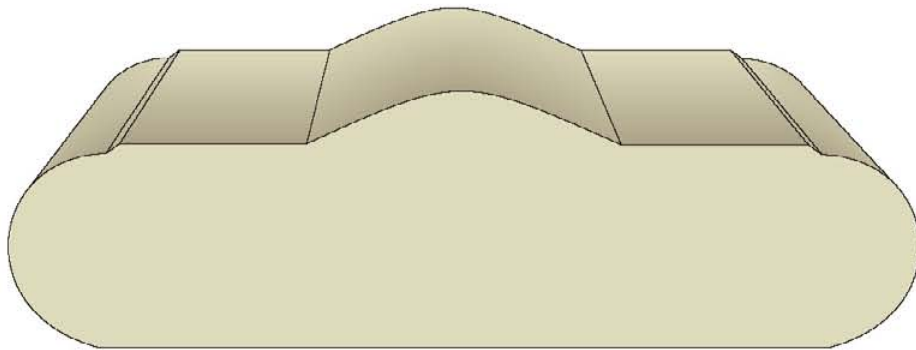

**HM620**  
1 3/8" X 4 3/4"

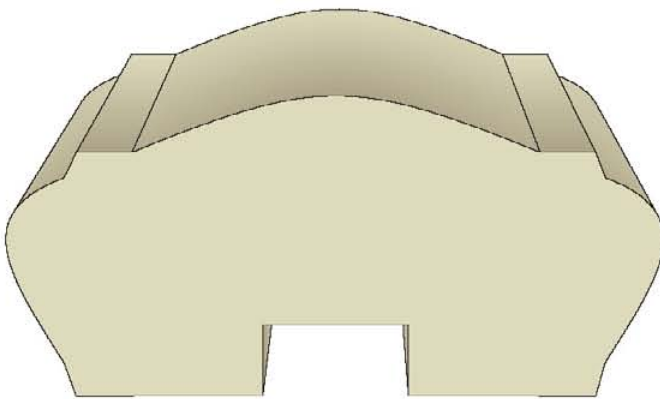

**HM420**  
1 1/2" X 3 1/2"

**BUILT-UP EXTERIOR HANDRAIL**

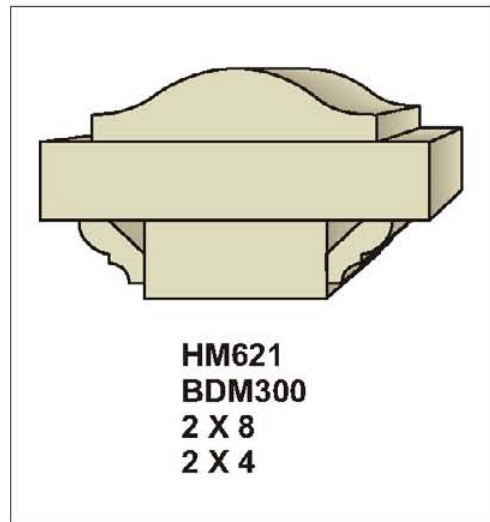

**HM621**  
**BDM300**  
2 X 8  
2 X 4

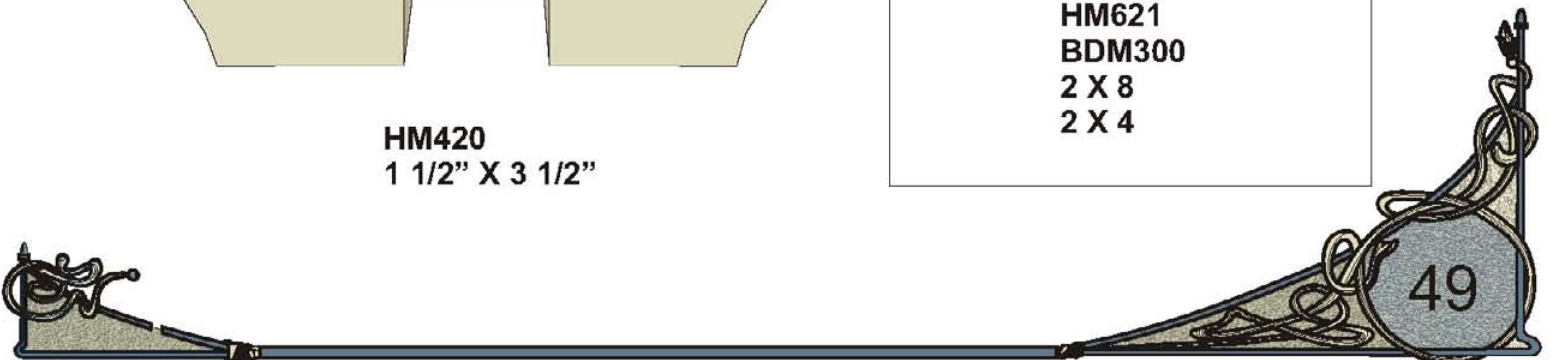

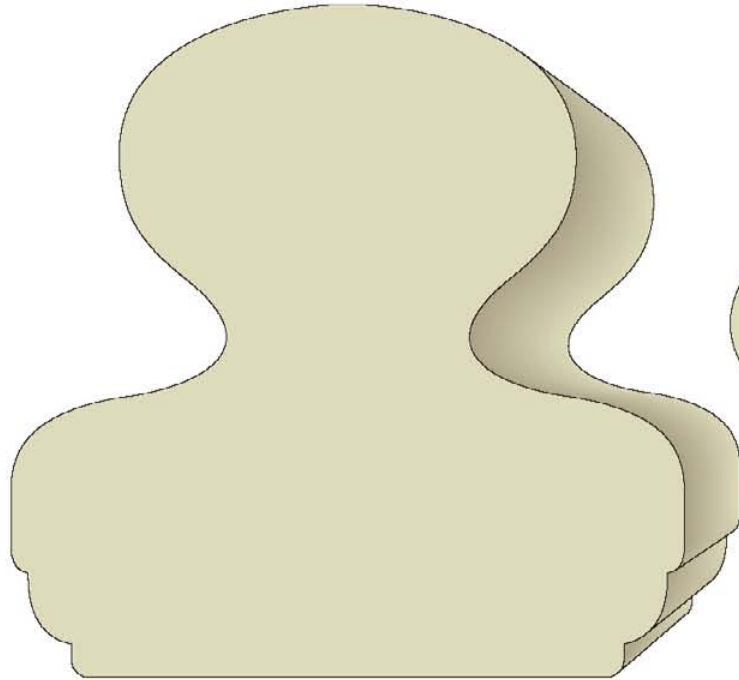
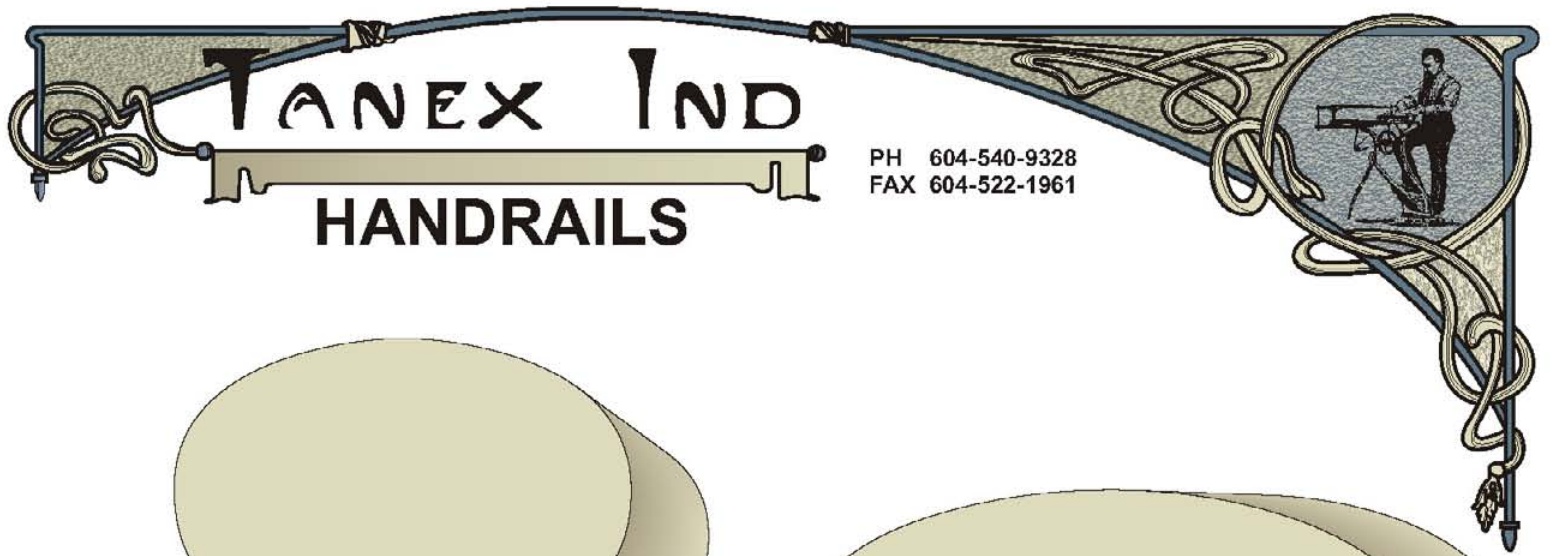

**HM445**  
3 1/2" X 3 1/2"

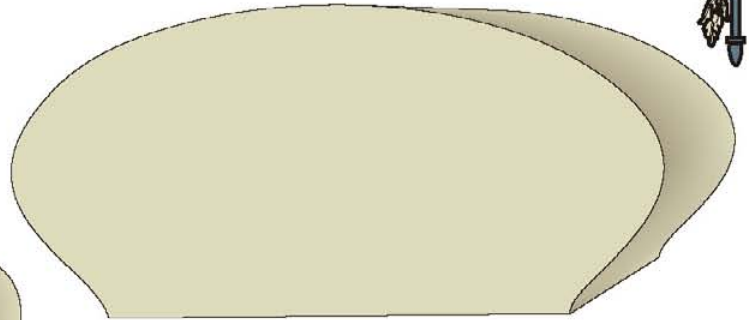

**HM421**  
1 11/16" X 3 5/16"

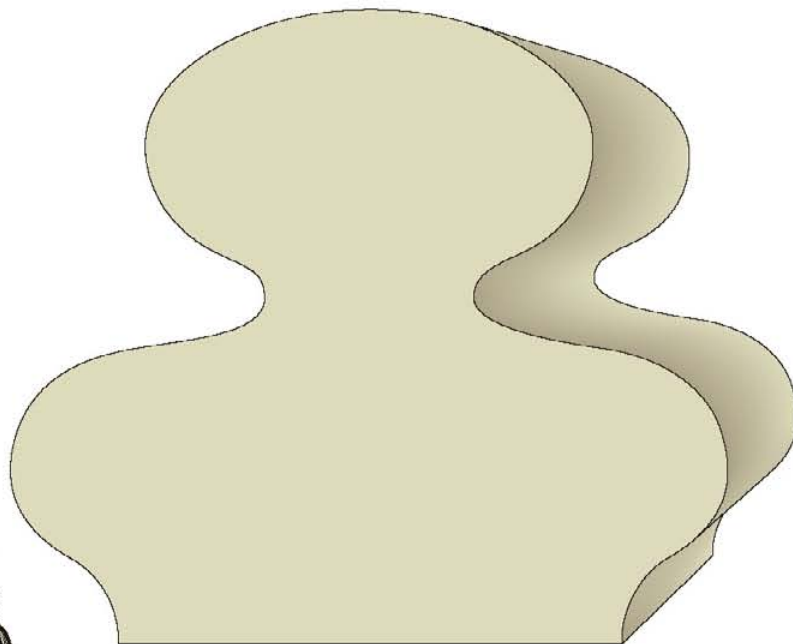

**HM447**  
3 5/16" X 3 11/16"

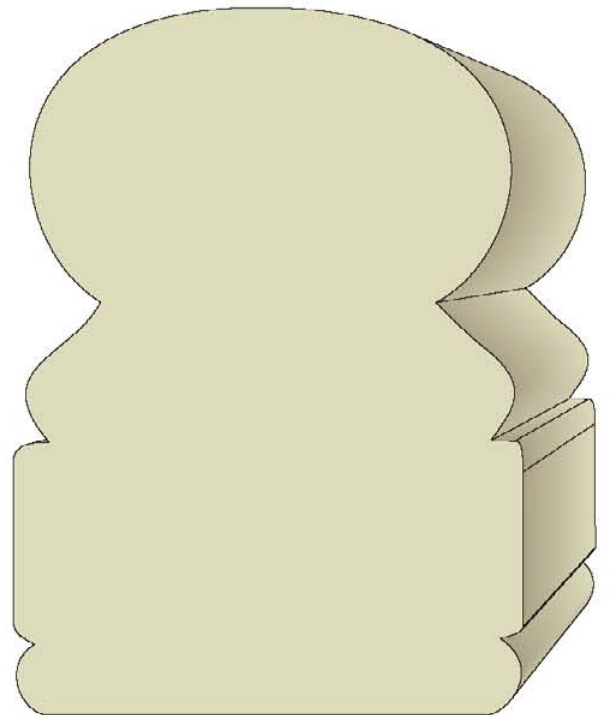

**HM430**  
2 11/16" X 3 11/16"

